

*Recommended Standards and Guidance for Performance,  
Application, Design, and Operation & Maintenance*

# **Intermittent Sand Filter Systems**

December 2016



*Recommended Standards and Guidance for  
Performance, Application, Design, and Operation & Maintenance*

# Intermittent Sand Filter Systems

December 2016



For information or additional copies of this report contact:  
Wastewater Management Program  
Physical address: 101 Israel Road SE, Tumwater, WA 98501  
Mailing Address: PO Box 47824, Olympia, Washington 98504-7824

Phone: (360) 236-3330  
FAX: (360) 236-2257  
Webpage: [www.doh.wa.gov/wastewater](http://www.doh.wa.gov/wastewater)  
Email: [wastewatermanagement@doh.wa.gov](mailto:wastewatermanagement@doh.wa.gov)

Umair A. Shah, MD, MPH  
Secretary of Health

To request this document in another format, call 1-800-525-0127. Deaf or hard of hearing customers, please call 711 (Washington Relay) or email [civil.rights@doh.wa.gov](mailto:civil.rights@doh.wa.gov).

Para solicitar este documento en otro formato, llame al 1-800-525-0127. Clientes sordos o con problemas de audición, favor de llamar al 711 (servicio de relé de Washington) o enviar un correo electrónico a [civil.rights@doh.wa.gov](mailto:civil.rights@doh.wa.gov).

DOH 337-007

<b>Contents</b>	<b>Page</b>
<b>Preface</b> .....	<b>4</b>
<b>Glossary of Terms</b> ..... <a href="http://www.doh.wa.gov/Portals/1/Documents/Pubs/337-028.pdf">http://www.doh.wa.gov/Portals/1/Documents/Pubs/337-028.pdf</a>	
<b>Introduction</b> .....	<b>6</b>
<b>1. Performance Standards</b> .....	<b>7</b>
<b>2. Application Standards</b> .....	<b>7</b>
2.1. Listing .....	7
2.2. Permitting.....	7
2.3. Influent Characteristics .....	7
2.4. Primary treatment.....	8
2.5. Location Requirements .....	8
2.6. Soil Dispersal Component .....	8
<b>3. Design Standards</b> .....	<b>10</b>
3.1. Design Approval .....	10
3.2. Filter Bed .....	10
3.3. Effluent Distribution .....	11
3.4. Minimum Dosing Frequency: .....	12
3.5. Filtrate (Treated Effluent) Collection and Discharge .....	13
3.6. Installation Issues.....	15
3.7. Monitoring Ports .....	16
<b>4. Operation and Maintenance Standards</b> .....	<b>18</b>
4.1. Management.....	18
4.2. Operation and Maintenance (O&M) Manual.....	18
4.3. Monitoring and Maintenance .....	19
4.4. Observed Conditions/Actions .....	20
<b>Appendix A – Filter Media Specifications</b> .....	<b>22</b>
<b>Appendix B - Containment Vessel Standards</b> .....	<b>24</b>
<b>Appendix C – Underdrains</b> .....	<b>30</b>
<b>Appendix D - Monitoring Ports</b> .....	<b>32</b>
<b>Appendix E - Disposal of Contaminated Filter Media</b> .....	<b>33</b>
<b>Appendix F - Bibliography</b> .....	<b>34</b>
<b>Figures</b>	
Figure 1. Typical Layout of an Intermittent Sand Filter.....	8
Figure 2. Typical Intermittent Sand Filter, Cross Section .....	11
Figure 3. Typical Intermittent Sand Filter, Top View .....	12
Figure 4. Example: Gravity Discharge to External Pump Tank, Cross Section .....	13
Figure 5. Example: Internal Pump Basin Assembly (w/ Float Setting Detail).....	14
Figure 6. Example: Sand Filter Construction Methods to Increase Aeration.....	16
Figure 7. Typical Cross-section of a Gravity Discharge Underdrain .....	31
Figure 8. Typical Cross-section of an Pump Discharge Underdrain .....	32
Figure 9. Typical Monitoring Ports .....	32

## Preface

The recommended standards in this document were developed for statewide application. Regional differences may, however, result in application of this technology in a manner different than what is presented here. In some areas, greater allowances than those described here may reasonably be granted. In other areas, allowances provided for in this document may be further restricted. In either case, the local health officer has full authority in the application of this technology, consistent with [chapter 246-272A WAC](#) and local jurisdictional rules. If any provision of these recommended standards is inconsistent with local jurisdictional rules, regulations, ordinances, policies, procedures, or practices, the local standards take precedence.

Local jurisdictional application of these recommended standards may be:

- 1) **Adopted as part of local rules, regulations or ordinances** - When the recommended standards, either as they are written or modified to more accurately reflect local conditions, are adopted as part of the local rules, their application is governed by local rule authority.
- 2) **Referred to as technical guidance in the application of the technology** - The recommended standards, either as they are written or modified to more accurately reflect local conditions, may be used locally as technical guidance.

Application of these recommended standards may also combine these two approaches. How these recommended standards are applied at the local jurisdictional level remains at the discretion of the local health officer and the local board of health, provided the application is consistent with the requirements in chapter 246-272A WAC.

These recommended standards are provided in typical rule language to assist those local jurisdictions where adoption in local rules is the preferred option. Other information and guidance is presented in text boxes with a modified font style to easily distinguish it from the recommended standards.

The recommended standards contained in this document have been primarily written to support the application of on-site sewage systems with design flows less than 3500 gpd, but may also be applied to large on-site sewage systems (LOSS).

With the adoption of the revised LOSS rule, [chapter 246-272B WAC](#), in 2011, some provisions of the RS&Gs may not be appropriate or allowed for LOSS. Many applicable requirements from the RS&Gs have already been included in the LOSS rule. Design engineers and others interested in LOSS are directed to consult the rule and LOSS program staff before or instead of the RS&Gs.

**Glossary of Terms:** A glossary of common terms for all RS&Gs can be found on the DOH Web site at <http://www.doh.wa.gov/Portals/1/Documents/Pubs/337-028.pdf>.

**Typical RS&G Organization:**

<b>Standards Section</b>	<b>Explanation</b>
Performance	How this technology is expected to perform (treatment level and function).
Application	How this technology is to be applied. This section includes conditions that must be met prior to proceeding with design. Topics in this section describe the “approved” status of the technology, component listing requirements, permitting, installation, testing and inspection requirements, etc.
Design	How this technology is to be designed and constructed (includes minimum standards that must be met to obtain a permit).
Operation and Maintenance	How this technology is to be operated and maintained (includes responsibilities of various parties, recommended maintenance tasks, frequency, assurance measures, etc.).
Appendices	Design examples, figures and tables, specific applications, and design and installation issues.

## Introduction

Intermittent sand filters provide biodegradation and decomposition of wastewater constituents by bringing the wastewater into close contact with a well-developed aerobic biological community attached to the surfaces of the filter media. This process requires unsaturated downward flow of the effluent through the filter media. The filter media may be mineral sand or equivalently sized crushed glass meeting one of the media specifications listed in Appendix A. The media is either contained in a watertight vessel below the surface of the ground, or wholly or partially elevated in a containment vessel. Proper function requires that influent to the filter be distributed over the media in controlled, uniform doses. In order to achieve accurate dosing, these systems require timed dosing with associated pump chambers, electrical components, and distribution network, with a minimum of 4 to 18 doses per day (depending on the sand media) spread evenly over a 24-hour period. Filtrate (treated effluent) is collected and discharged from the bottom of the sand filter by either a gravity discharge underdrain or a pump discharge underdrain.

This technology is used on sites with shallow soil conditions where treatment must be accomplished before the effluent is discharged into the soil. Intermittent sand filter effluent may be dispersed to a soil profile containing as little as 12 inches of vertical separation in soil types 2 through 6. Intermittent sand filters are also used as part of a mitigation strategy when horizontal separations are reduced.

## 1. Performance Standards

When properly sited, designed, installed, operated, and maintained, an intermittent sand filter system consistent with these recommended standards and guidance is expected to achieve treatment performance equal to Treatment Level B.

## 2. Application Standards

### 2.1. Listing

- 2.1.1. Intermittent sand filters are a public domain treatment technology and are included in the Department of Health's [List of Registered On-site Treatment and Distribution Products](#) (Registered List) as a Category 1 treatment technology.

### 2.2. Permitting

- 2.2.1. Installation and, if required, operational permits must be obtained from the appropriate local health officer prior to installation and use.

### 2.3. Influent Characteristics

- 2.3.1. Residential Wastewater: Intermittent sand filters are designed for treating residential-strength wastewater. The wastewater applied to the intermittent sand filter must not be higher in strength than treatment level E, or grab samples with results no greater than 220 mg/l BOD5 or 145 mg/l TSS. Lower wastewater strengths, without increased flow rates are preferable for assuring long-term operation of an intermittent sand filter system.
- 2.3.2. Non-Residential Wastewater: High-strength wastewater and wastewater from non-domestic sources (such as restaurants, hotels, bed and breakfast establishments, industrial and commercial wastewater sources) must be individually evaluated for treatability and the degree of primary treatment required prior to an intermittent sand filter and the soil dispersal component.
- 2.3.3. Design Flow
  - 2.3.3.1. Residential - For all residential applications, a minimum wastewater design flow of at least 120 gallons/bedroom/day must be used.
  - 2.3.3.2. Non-Residential - For non-residential applications, a minimum wastewater design flow equal to 150% of the estimated daily flow must be used.

## 2.4. Primary treatment

- 2.4.1. For residential sewage, settleable and floatable solid separation must be accomplished using a properly sized, two-compartment septic tank with effluent baffle screening.
- 2.4.2. Primary treatment with another registered wastewater sedimentation/initial treatment unit may be used, if included on the Registered List as a treatment product, instead of a septic tank.
- 2.4.3. For wastewater from non-domestic sources, influent to the sand filter must be equivalent to residential strength septic tank effluent.

*Aerobic treatment, or some other treatment process, may be needed to modify the influent to the intermittent sand filter to within the range of residential septic tank effluent quality.*

## 2.5. Location Requirements

- 2.5.1. The minimum setback requirements for intermittent sand filters are the same as required for sewage tanks (WAC 262-272A-0210).

**Figure 1 - Typical Layout of an Intermittent Sand Filter**

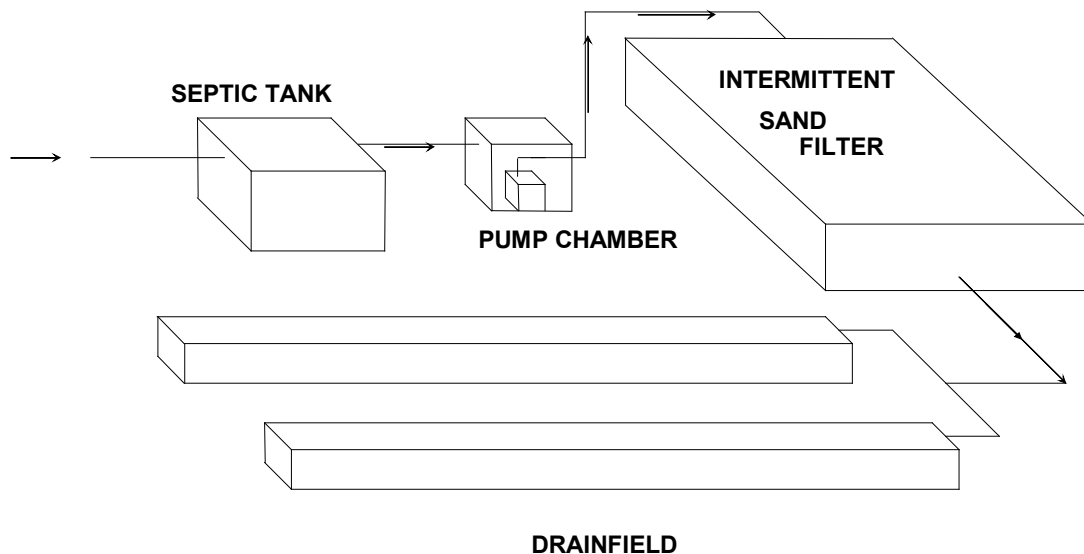

## 2.6. Soil Dispersal Component

- 2.6.1. Discharge of effluent from an intermittent sand filter to a soil dispersal component is required. Direct discharge of effluent from an intermittent sand



filter to surface water or upon the ground surface is prohibited by WAC 246-272A-0230(2)(a).

- 2.6.2. The soil dispersal component's distribution system, typically a pressure distribution system, following an intermittent sand filter must meet the method of distribution requirements for soil dispersal components in WAC 246-272A-0230 and WAC 246-272A-0280. The soil dispersal component can be demand dosed and still meet the requirements of timed dosing since it follows a timed dosed intermittent sand filter. The timer for the intermittent sand filter indirectly controls the downstream demand dosed delivery of effluent to the soil dispersal component so that a second timer for the soil dispersal component is not needed.

*Based on field maintenance feedback, demand dosing a soil dispersal component following an intermittent sand filter may lead to hydraulic overloading, especially in subsurface drip drainfields for various reasons, such as in areas with excessive rainfall or failure of the pump or floats. If this might be a problem, it is advisable to require a timer for the subsurface drip drainfield instead of demand dosing to the drainfield.*

- 2.6.3. WAC 246-272A provides for soil dispersal component design allowances, which vary according to treatment performance levels.
- 2.6.4. The size and design of the soil dispersal component must be consistent with the methods and procedures in WAC 246-272A-0200, WAC 246-272A-0220, WAC 246-272A-0230, and WAC 246-272A-0234.
- 2.6.5. The soil dispersal component location must meet minimum horizontal setback distances in WAC 246-272A-0210 and 246-272A-0280.
- 2.6.6. Intermittent sand filters must meet the minimum land area requirements in WAC 246-272A-0320.

*Generally, when the site evaluation indicates the depth of soil to a water table is less than 18 inches, there is a need to confirm that there are at least 12 inches during the wet season. Therefore, when there is any doubt that there is sufficient unsaturated soil depth, the permit should be held for a wet season evaluation to accurately identify the location of high water tables. As potential vertical separation decreases, seasonal site checks to evaluate water table levels become increasingly critical to the on-site sewage system design, function, and the protection of public health.*

### 3. Design Standards

#### 3.1. Design Approval

Before construction can begin, the design must be approved by local health or other appropriate jurisdiction. All site inspections before, during, and after the construction must be accomplished by local health, other appropriate jurisdiction, or by a designer or engineer appointed by the appropriate jurisdiction.

#### 3.2. Filter Bed

- 3.2.1. Media Specifications: Filter media must meet either the Coarse Sand Media or ASTM C-33 specification for particle size graduation detailed in Appendix A. Filter media used in constructing a sand filter must be accompanied with a written certification from the supplier that the sand fully conforms to one of the media specifications listed in Appendix A, as determined by ASTM C-136 (dry sieving) and ASTM C-117 (wet sieving).
- 3.2.2. Filter Bed Sizing
  - 3.2.2.1. Hydraulic Loading Rate: The loading rate to the sand filter must not exceed 1.0 gallons/day/square foot, using appropriate daily wastewater flow design estimate.
  - 3.2.2.2. Surface area of filter bed: The surface area must be determined by dividing the design flow estimate by the loading rate.
  - 3.2.2.3. An increase in the hydraulic loading beyond the maximum 1.0 gallons/day/square foot (reduction in surface area of the installed filter bed) is not permitted when using either a gravelless distribution product in the filter bed or a treatment technology preceding the sand filter that meets or exceeds Treatment Level D.
- 3.2.3. Depth of filter media: The media depth in the filter bed must be a minimum of 24 inches.
- 3.2.4. Filter bed containment: The filter bed must be contained in either a synthetic membrane liner or an engineer designed concrete cast-in-place containment vessel. Design and construction must conform to the containment vessel standards set forth in Appendix B for synthetic membrane liners or WAC 246-272C for cast-in-place concrete containment vessels.

**Figure 2 - Typical Intermittent Sand Filter, Cross Section**

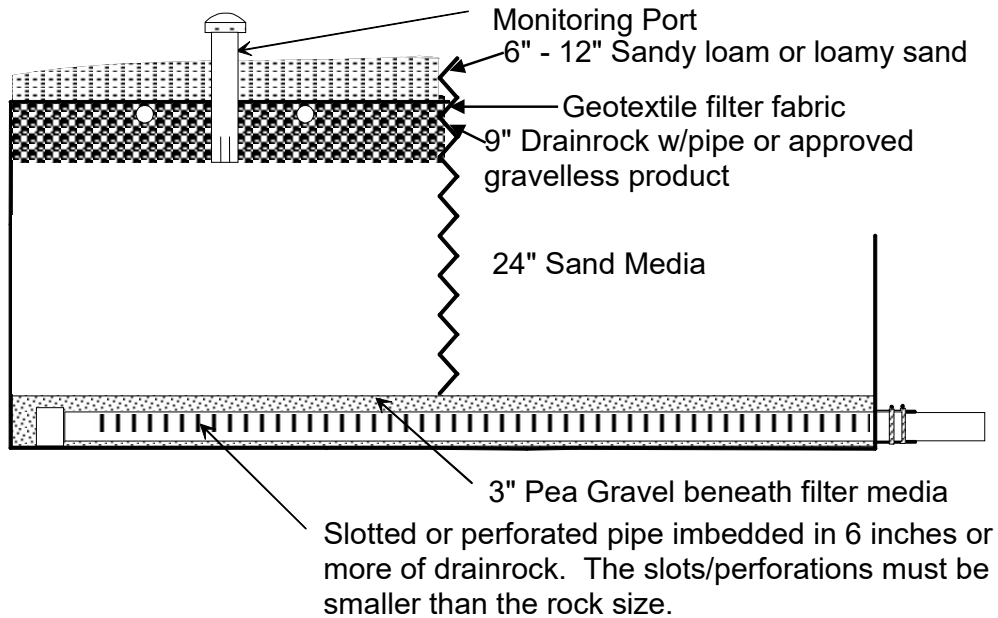

### 3.3. Effluent Distribution

Pressure distribution: The distribution system, pump chamber, and all other pressure distribution related components must be designed according to the Recommended Standards and Guidance for Pressure Distribution Systems or Subsurface Drip Systems.

- 3.3.1. The effluent must be applied to the layer of drainrock on top of the filter media by pressure distribution or, it must be applied to the filter media by pressure distribution using a proprietary distribution product (PDP), such as a gravelless distribution or subsurface dripline product, in place of the layer of drainrock.
- 3.3.2. When a PDP is used in an intermittent sand filter system, the pressure distribution network must be designed to assure the effluent is applied to the filter media in a manner to achieve uniform distribution while minimizing erosion of the infiltrative surface. For example, pointing orifices up in pressure distribution laterals to spray effluent upward against the top of gravelless chambers to dissipate the energy of the applied flow.
- 3.3.3. Only PDP on the current List of Registered On-site Treatment and Distribution Products may be permitted by the local health jurisdiction.

**Figure 3 - Typical Intermittent Sand Filter, Top View**

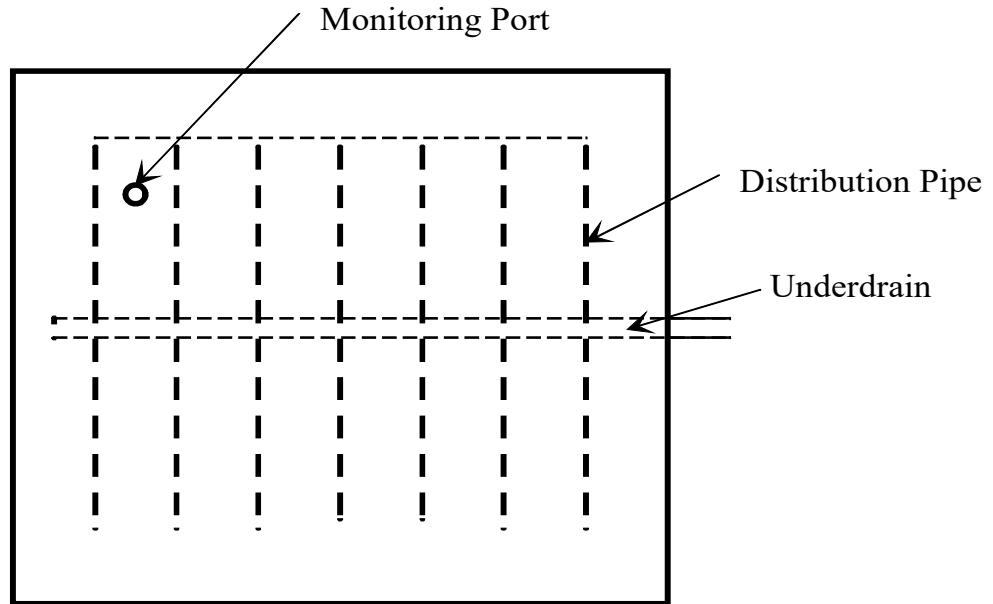

**3.4. Minimum Dosing Frequency:**

3.4.1. A timed dosing system is required. The dosing frequency or dose volume is dependent on the media specification used with the sand filter. To assure that appropriate dose volumes are delivered to the sand filter, the timer must be set to dose the filter at the following minimum dosing frequency:

<u>Media Specification</u>	<u>Minimum Number of Doses/Day</u>
Coarse Sand Media	18 times per day
ASTM C-33	4 times per day

*With frequent dosing (i.e., greater than 12 doses/day) very little effluent is applied to the filter at any one dose resulting in unsaturated film-like flow. If the dose volume exceeds the water holding capacity of the filter media, the applied liquid fills the pore spaces allowing the wastewater to pass through the filter untreated. However, if the dose volume does not exceed the water holding capacity of the media, the applied wastewater will flow around the sand grains in a thin film maximizing oxygen diffusion, and maximizing contact between the organics in the effluent and the microbial growth on the media. The filter media meeting the Coarse Sand Media specification has a lower water holding capacity than the sand meeting the ASTM C-33 specification. Thus, a smaller dose volume or higher dosing frequency is required to promote the unsaturated film-like flow. Because of the larger unit wetted surface area of ASTM C-33 sand, a larger volume of wastewater may be applied at one time without exceeding its water holding capacity. The large surface allows unsaturated flow conditions to occur at a higher dose volume or lower dosing frequency.*

### 3.5. Filtrate (Treated Effluent) Collection and Discharge

- 3.5.1. Filtrate can be collected and discharged from the bottom of the sand filter by either a gravity-flow underdrain or a pump discharge underdrain. When a gravity discharge underdrain is used the filtrate flows by gravity, usually to a pump tank located outside the intermittent sand filter. When a pump discharge underdrain is used, a pump basin assembly is located inside the intermittent sand filter.
- 3.5.2. Gravity discharge underdrain to an external pump tank (see Figure 4):
  - 3.5.2.1. When the sand filter has a synthetic membrane liner the gravity flow underdrain must exit through a boot. The boot and exit pipe must be installed and tested according to the standards in Appendix B.
  - 3.5.2.2. External pump tanks must be included in the Department of Health List of Registered Sewage Tanks.
    - 3.5.2.2.1. For a demand dosed system: The pump tank must be sized large enough to provide the daily design flow volume, dead space below the pump inlet for sludge accumulation, and sufficient depth to provide full time pump submergence, when required. An additional emergency storage volume of at least 75% of the daily design flow is also required.
    - 3.5.2.2.2. For a timed dosing subsurface drip system: The pump tank that doses to a subsurface drip field must be a minimum volume of 1000 gallons for single-family residential applications. For all other applications the minimum pump chamber size depends on design flow (see RS&G for Subsurface Drip Systems). Pump tanks must be installed in a manner that maximizes available storage.

**Figure 4 - Example: Gravity Discharge Underdrain to External Pump Tank, Cross Section**

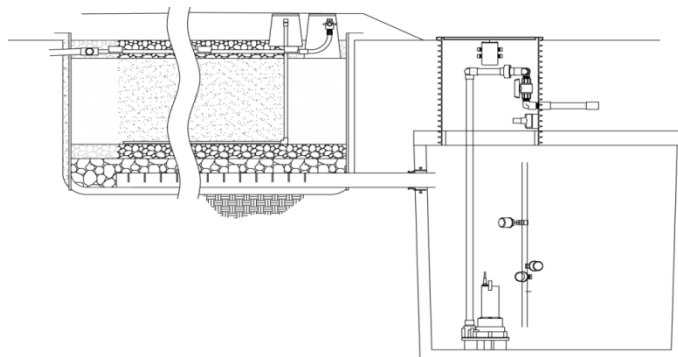

- 3.5.3. Pump discharge underdrains (internal pump basin assembly). See Appendix C Underdrains for additional information.

- 3.5.3.1. The pump basin must be on the Department of Health's List of Registered Sewage Tanks.
- 3.5.3.2. The underdrain system must be designed with sufficient void storage volume to provide for a single drainfield dose with reserve capacity to maintain unsaturated filter media above the underdrain. Gravel depths to at least 8 inches are required to assure adequate storage volume. In addition, a minimum 4 inch pea gravel layer is placed over the gravel layer to help prevent sand from being sucked down into the gravel during pump cycling events. The pump basin's liquid level float must be set below the filter media so that the water level in the underdrain is always kept below the filter media. See Figure 5 for an example of float setting detail.

*Saturation will occur close to or in the filter media if the liquid level rises above the underdrain, thereby limiting the oxygen supply to the sand filter. The float tree and floats must be set so that the high water alarm float is below the bottom of the pea gravel layer to prevent the sand filter from being flooded. In addition, the alarm float must be wired to the dosing pump controls so that any high water event within the sand filter bed will automatically deactivate the pump to the sand filter. The on/off floats should be set for the pump in the pumpwell to cycle at the level of the underdrain pipes. Preferably, the on-float is set to activate once the liquid level reaches the crown of the underdrain pipes or slightly below, and the pump-off float is positioned somewhere above the invert of the underdrain pipes.*

**Figure 5 - Example: Internal Pump Basin Assembly (w/ Float Setting Detail)**

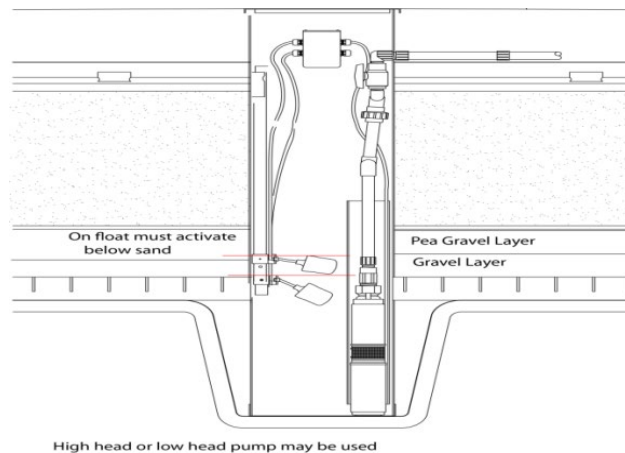

- 3.5.4. Determining the drawdown for the dose from the pumpwell. The gallons per inch of the gravel underdrain can be determined by:
  - a. multiply underdrain width x length x depth (in feet) to get volume of underdrain in cubic feet;
  - b. multiply cubic feet by 7.48 to get volume of underdrain in gallons;

- c. divide gallons by underdrain depth (in inches) to get gallons per inch of underdrain;
- d. multiply gallons per inch by 0.3 (30% assumed void space value of gravel) to get gallons per inch of void space (liquid volume – the liquid) goes into the void space; and
- e. divide gallons per dose by gallons per inch of void space (step d) to determine inches per dose.

### 3.6. Installation Issues

- 3.6.1. Intermittent sand filter containment vessels constructed with a 30 mil PVC liner, must have the liner protected by a 3 inch minimum layer of sand beneath the liner. See Appendix A for additional installation standards for synthetic membrane-lined pits.
- 3.6.2. In order to prevent differential settling when the sand filter is put into service, the filter media must have a uniform density throughout.

*Uniform density may be accomplished one of two ways, depending on the moisture content of the filter media during construction. If the filter media is dry enough that it can be poured (like salt or sand in an hourglass), it can simply be poured to fill the sand filter frame, then settled lightly (not compacted) to allow about 5% settling-i.e., volume reduction. However, if the filter media is moist enough that it cannot be poured, it should be placed in successive 6-inch lifts with each lift lightly settled. The intent of the light settling in both cases is to eliminate large voids in the media that may collapse later when effluent is added. The light settling may be accomplished by walking on the sand, then raking (with hand tools) into the corners, along the sides, around the pump basin (if applicable) and around monitoring ports. The final bulk density should be approximately 1.3 to 1.4 g/cm<sup>3</sup> (81.2 to 87.4 lb/ft<sup>3</sup>). Higher densities will reduce infiltration rates and oxygen exchange potential.*

- 3.6.3. A geotextile filter fabric must be placed on the gravel bed to prevent cover soil fines from moving down into the drainrock while allowing air and water to pass through freely. Cover soil (sandy loam or coarser) must be capable of maintaining vegetative growth while not impeding the passage of air to the filter bed. The soil cover must be crowned or sloped to provide drainage off and away from the sand filter.

*Because diffusion through the soil cover is the only source of oxygen for the sand filter, soil depth, texture, and geotextile fabric over the filter are important factors to consider for maximizing oxygen transfer into the system. It is important not to use a heavy filter fabric that impairs air and water movement, which could cause the sand filter to clog and turn anaerobic. Preferred soil cover types are loamy sand or coarser, with a thickness of 6 to 8 inches, to allow free movement of air into the sand filter.*

3.6.4. Intermittent sand filters can be prone to premature clogging when ASTM C-33 sand is used as the filter media and/or when subjected to high periodic organic loadings. In these situations the sand filter can benefit from methods that increase aeration within the filter bed. Installation methods that may help increase aeration in the filter include:

- A port connected as a “T” to the underdrain with a vented cap at grade.
- Ports on each end of the underdrain slotted pipe or underdrain gravelless chamber extending to grade with vented caps.
- An air coil system that provides supplemental air into the sand filter at the pea gravel/sand media interface.
- A six-inch wide column of filter media around the side of the filter bed extending from grade to the filter media. See figure 6.
- Vented locking lid on an internal pump basin. See figure 6.

**Figure 6 - Examples of Sand Filter Construction Methods to Increase Aeration**

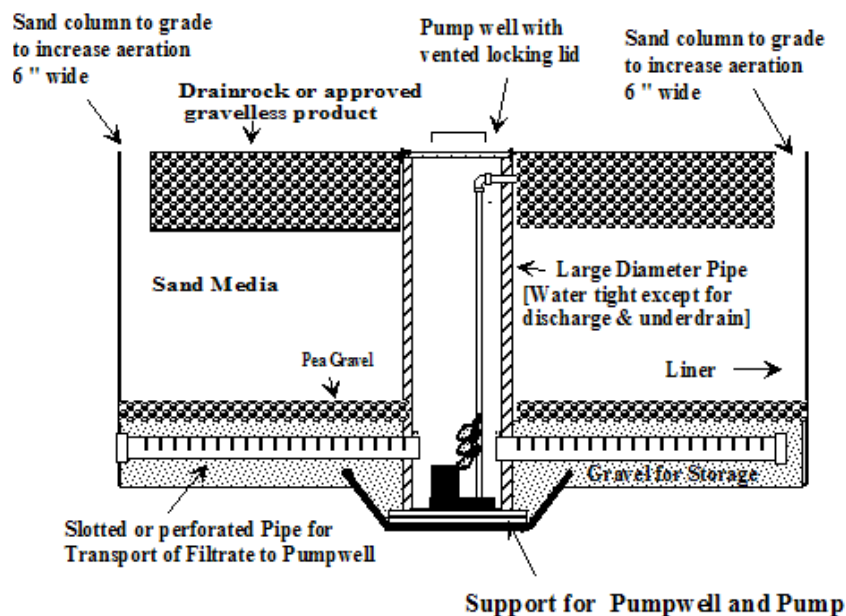

### 3.7. Monitoring Ports

3.7.1. The installation of monitoring ports in an intermittent sand filter is for the purpose of monitoring system status and aiding in problem analysis. If the intermittent sand filter effluent exits the sand filter through the underdrain by gravity flow, two monitoring ports must be installed in the sand filter. One monitoring port must be installed to the bottom of the drainrock/top of the media interface, or the top of the media if gravelless chambers are used in place of the layer of drainrock. A second monitoring port must be installed to the bottom of the underdrain. If the effluent exits the sand filter through a pump basin, the pump basin may be used as the second monitoring port. Some lines may require additional monitoring ports to achieve observations representative of the entire



sand filter bed. Methods of installing and securing observation ports are provided in Appendix D. Well-designed and installed monitoring ports:

- Extend to at least the ground surface of the final landscape grade surface;
- Are firmly anchored to prohibited unauthorized removal;
- Are accessible for routine observation;
- Are secured or otherwise protected for accidental or unauthorized access;
- Provide visual access to the filter bed-bottom in the gravel portion of a gravel-filled sand filter and in gravelless chambers to the interior of the chamber.

## **4. Operation and Maintenance Standards**

### **4.1. Management**

- 4.1.1. The local health officer may require a maintenance agreement with supporting legal documents before approving a proposed intermittent sand filter system. Maintenance agreements are recommended when, in the opinion of the local health authority, the optimum operation of the intermittent sand filter system is assured by such an agreement.
- 4.1.2. **Owner Responsibilities:** The owner of the residence or facility served by an intermittent sand filter system is responsible for assuring proper operation and providing timely maintenance for all components of the on-site wastewater treatment and soil dispersal system. This includes inspecting the entire system at a frequency appropriate for the site conditions and the type of on-site sewage system as specified by the local health jurisdiction. Contact the local health department/district for what qualifications are required of a person to perform any specialized monitoring and maintenance activities.

### **4.2. Operation and Maintenance (O&M) Manual**

- 4.2.1. An O&M manual for the intermittent sand filter system must be provided by the system designer. The manual must contain the following:
  - 4.2.1.1. The system owner's responsibilities, including established system operation, inspection, recording keeping, reporting, and permit requirements.
  - 4.2.1.2. Key contact information, including names and telephone numbers of the local health authority, system designer, component manufacturer, supplier/installer, and the management entity to be contacted in the event of an emergency or system failure.
  - 4.2.1.3. Design description including, a narrative that describe how the system works, its intended performance, and operating limits of the design. The narrative should include a brief description of each major process or component and discuss its function in the system and its expected performance. For proprietary products, include manufacturer's standard product literature with performance specifications and maintenance recommendations needed for operation, monitoring, and maintenance.
  - 4.2.1.4. Diagrams of the all major system components, including system design drawings, system record drawing (as-builts), and schematics for all electrical and mechanical components installed.
  - 4.2.1.5. Information on the periodic monitoring and maintenance requirements of the system. List and describe monitoring and maintenance activities for

septic tank, dosing tanks, sand filter, drainfield, control panel, pumps, motors, switches, alarms, etc. including recommended component settings for routine operation and monitoring.

- 4.2.1.6. A list and description of key operating activities and measures that should be employed or avoided to protect the sewage system's treatment processes and components. Examples include use of low flow fixtures, spreading out laundry and other high water use activities over several days, selective and limited use of bleach and other household chemicals, elimination of garbage grinders, not disposing unwanted and outdated medications down the drain, and maintaining suitable soil cover, landscaping and vegetation for the sand lined trench system and the reserve area.
- 4.2.1.7. A trouble-shooting guide, including information on "trouble-shooting" common operational problems that might occur. This information should be detailed and complete as needed to assist the system owner to make accurate decisions about when and how to attempt corrections of operational problems, and when to call for professional assistance.

### **4.3. Monitoring and Maintenance**

- 4.3.1. Minimum monitoring and maintenance activities for intermittent sand filter systems include:
  - 4.3.1.1. Inspect septic tank yearly for structural integrity, proper baffling, ground water intrusion, and proper sizing. Inspect and clean effluent baffle screen and also pump tank as needed;
  - 4.3.1.2. Pump dosing tanks, clean the effluent screen, inspect and clean the pump switches and floats yearly. Pump the accumulated sludge from the bottom of the chambers whenever the septic tank is pumped, or more often if necessary;
  - 4.3.1.3. Check monitoring ports for ponding. Conditions in the monitoring ports must be observed and recorded by the service provider during all operation and maintenance activities for the intermittent sand filter and other system components. The person monitoring the system needs to be aware of the impact of dose frequency has on the observed ponding level;
  - 4.3.1.4. Inspect and test yearly for malfunction of electrical equipment such as timers, counters, control boxes, pump switches, floats, alarm system or other electrical components, and repair as needed. System checks should include improper setting or failure of electrical, mechanical, or manual switches;

- 4.3.1.5. Check for mechanical malfunctions (other than those affecting sewage pumps) including problems with valves or other mechanical or plumbing components;
- 4.3.1.6. Check for material fatigue, failure, corrosion, or use of improper materials, as related to construction or structural design;
- 4.3.1.7. Check for system neglect or improper use, such as hydraulic or organic loading beyond the operating capacity, introduction of toxic or hazardous substances into the system, extraneous flows into system, drainage from surface runoff or non-sewage drains directed towards where the system is located, soil compaction, damage by soil removal and grade alteration, and unsuitable cover material or vegetation;
- 4.3.1.8. Check building usage for changes in wastewater strength, hydraulic flow, or other conditions that could affect the performance of the intermittent sand filter and/or the entire system. Sampling, testing, and troubleshooting may be required by the local health officer on a case-by-case basis, depending on the nature of the problem, availability of laboratories, or other factors. This may include sampling of specific chemical/biological indicators, such as BOD, TSS, fecal coliforms, etc.;
- 4.3.1.9. Check for system installation problems such as improper location or failure to follow design;
- 4.3.1.10. Check for overflow or backup problems where sewage is involved;
- 4.3.1.11. Maintain a written chronological record of ponding level observations, and monitoring and maintenance activities. If the system has a reduced size drainfield, this should be included in the report to the local health jurisdiction responsible for permitting the system;
- 4.3.1.12. Service all system components as needed, including product manufacturer's requirements/recommendations for service.

#### **4.4. Observed Conditions/Actions**

- 4.4.1. When a system evaluation, or any other observation, reveals either of the following listed conditions, the owner of the system must take appropriate action to correct the situation according to the direction and approval of the local health officer:
  - 4.4.1.1. System failure, as defined in WAC 246-272A-0010, or
  - 4.4.1.2. A history of long-term, continuous and increasing ponding of effluent within the system of such magnitude, if left unresolved, will probably result in untimely system or component failure.

4.4.2. Appropriate actions include:

- 4.4.2.1. Evaluation of building usage for a change in wastewater quality or other conditions that could be causing the observed ponding within the system or failure;
- 4.4.2.2. Repair or modification of the on-site sewage system;
- 4.4.2.3. Expansion of the on-site sewage system; or
- 4.4.2.4. Modifications or changes within the structure relative to wastewater strength or hydraulic flows.

*Local permits must be obtained before construction begins, according to local health jurisdiction requirements. Any observed problem, repair or modification activity must be reported as part of the monitoring activity for the site. For an on-site sewage system with a reduced size drainfield, the repair or modification required may include the installation of additional drainfield to enlarge the system to 100% of the initial design size. Repair or modification is not limited to this option.*

**Appendix A – Filter Media Specifications**

**I Particle Size Analysis** - The standard method to be used for performing particle size analysis must comply with one of the following:

- A. the sieve method specified in ASTM C-136 and ASTM C-117
- B. the method specified in Soil Survey Laboratory Methods and Procedures for Collecting Soil Samples, Soil Survey Investigation Report #1, US Department of Agriculture, 1984.

**II Intermittent Sand Filter Media** - The filter media must meet either specification A. or specification B, below as determined by section I. Particle Size Analysis. Media may be either mineral sand or equivalently sized crushed glass.

**A. Coarse Sand Media Specification** - The filter media must meet items 1, 2, and 3 below: (Source: State of Oregon On-Site Sewage Disposal Rules and the State of Wisconsin Single Pass Sand Filter Component Manual)

1. Particle size distribution:

<u>Sieve</u>	<u>Particle Size</u>	<u>Percent Passing</u>
3/8 in	9.50 mm	100
No. 4	4.75 mm	95 to 100
No. 8	2.36 mm	80 to 100
No. 16	1.18 mm	45 to 85
No. 30	0.6 mm	15 to 60
No. 50	0.3 mm	3 to 15
No. 100	0.15 mm	0 to 4

2. Effective Particle Size (D<sub>10</sub>): 0.3 mm – 0.5 mm

3. Uniformity Coefficient (D<sub>60</sub>/ D<sub>10</sub>): < 4.0

*Concerns have been expressed about the potential for premature clogging/failure of sand filters with filter media meeting the ASTM C-33 specification. ASTM C-33 particle size distribution allows smaller sand particles to fill voids between large particles, resulting in smaller and more convoluted pore spaces. While this condition provides a high degree of wastewater treatment, it encourages clogging of the remaining void spaces, resulting in a greater chance of a restrictive biomat forming. By limiting the fine particles allowed, the Coarse Sand Media (CSM) specification is more clog-resistant in providing the needed degree of treatment when wastewater is stronger than expected, flows are high, or other unexpected factors occur. The use of the CSM specification, while not reducing the treatment efficiency of the sand filter, requires a lower volume, higher dosing frequency pattern to be used. The smaller dose provides better contact for the wastewater with the bacteria, and the sand will be less saturated, allowing for sufficient diffusion of oxygen into the system. See Section 3.4 for the minimum dosing frequency required with the CSM used as the filter media.*

**B. ASTM C-33 Specification** - The filter media must meet items 1, 2, and 3 below:  
(Source: ASTM C-33-99a, Specification for Fine Aggregate)

**1.** Particle size distribution:

<u>Sieve</u>	<u>Particle Size</u>	<u>Percent Passing</u>
3/8 in	9.50 mm	100
No. 4	4.75 mm	95 to 100
No. 8	2.36 mm	80 to 100
No. 16	1.18 mm	50 to 85
No. 30	0.6 mm	25 to 60
No. 50	0.3 mm	5 to 30
No. 100	0.15 mm	0 to 10 (prefer <4)
No. 200	0.075 mm	0 to 3 (prefer 0)

- 2.** The sand must have not more than 45% pass any one sieve and be retained on the next consecutive sieve of those shown above.
- 3.** The fineness modulus must be neither less than 2.3 nor more than 3.1. The fineness modulus is calculated by adding the cumulative percentages of material in the sample retained in the sieves shown above and dividing the sum by 100.

*Several possible factors have been discussed for premature failure and/or clogging of intermittent sand filters with ASTM C-33 sand as the filter media. These include: the ASTM C-33 specification allows for too large of a percentage of fine material (passing a No. 100 sieve) which may cause the finer material to become suspended in the filter causing an impermeable barrier near the top of the filter; loading rates of 1.0 gal/ft<sup>2</sup>/day are inappropriate and should be reduced. While the Technical Review Committee acknowledges these concerns, the committee feels that the data presented is inconclusive at this time. To address premature clogging of ASTM C-33 sands, the following suggestions are provided:*

- *reduce loading rates applied to intermittent sand filters to no more than 0.8 gal/ft<sup>2</sup>/day.*

- *incorporate into the system design methods of improving oxygen exchange within the filter such as; increasing the dose frequency and/or including a venting system in the filter with vents extended to the atmosphere. Vents may need to include an odor scouring device such as an activated carbon filter installed on the end of the vent.*
- *quality control of the sand media, such as frequent testing of the media to ensure that the media used consistently meets the ASTM C-33 specification.*



## Appendix B - Containment Vessel Standards

**I. Synthetic Membrane Lined Pit:** when a sand filter is constructed in a synthetic membrane lined excavated pit, the following criteria must be met: (Note: The majority of the following liner specifications are from the State of Oregon's On-Site Sewage Disposal Rules.)

**A. Polyvinyl chloride (PVC) membrane liners** shall have the following properties:

PROPERTY	TEST METHOD	
(a) Thickness	ASTM D1593 Para 9.1.3	30 mil Minimum
(b) Specific Gravity (Minimum)	ASTM D792 Method A	
(c) Minimum Tensile Properties (each direction)	ASTM D882	
(A) Breaking Factor (pounds/inch width)	Method A or B (1 inch wide)	69
(B) Elongation at Break (percent)	Method A or B	300
(C) Modulus (force) at 100% Elongation (pounds/inch width)	Method A or B	27
(d) Tear Resistance (pounds, minimum)	ASTM D1004 Die C	8
(e) Low Temperature	ASTM D1790	-20°F
(f) Dimensional Stability (each direction, percent change maximum)	ASTM D1204 212°F, 15 min.	± 5
(g) Water Extraction	ASTM D1239	-0.35% max.
(h) Volatile Loss	ASTM D1203 Method A	0.7% max.
(i) Resistance to Soil Burial (percent change maximum in original value)	ASTM D3083	
(A) Breaking Factor		-5
(B) Elongation at Break		-20
(C) Modulus at 100% Elongation		±10
(j) Bonded Seam Strength (factory seam, breaking factor, ppi width)	ASTM D3083	55.2
(k) Hydrostatic Resistance	ASTM D751 Method A	82

### B. Installation Standards

1. Patches, repairs, and seams of membrane liners must have the same physical properties as the parent membrane material;
2. Site considerations and preparation:

- a. The supporting surface slopes and foundation to accept the liner must be stable and structurally sound including appropriate compaction. Make sure the potential for sink hole development and differential settlement is avoided;
  - b. Soil stabilizers such as cementations or chemical binding agents must not adversely affect the membrane because they are potentially abrasive agents.
3. To avoid deterioration of the membrane liner caused by exposure to weather or sunlight, the liner must be protected by being fully buried. In cases where portions of the liner may be subjected to direct exposure to the weather, the exposed portions of the liner must be covered. A construction option to accomplish this is to install a finish rim over the exposed liner portions.
4. Non-reinforced liners have high elongation and can conform to irregular surfaces and follow settlements within limits. Unreasonable strain reduces thickness and may reduce life expectancy by lessening the chemical resistance of the thinner (stretched) material. Membrane liners must be installed to minimize strain (or elongation to the fabric) anywhere in the flexible membrane liner system;
5. Construction and installation:
- a. The bottom of the pit must be covered with:
    - (1) Sand to "bed" liner, at a minimum depth of 3 inches to protect liner from punctures, or
    - (2) A non-woven, needle-punched synthetic geotextile fabric with a thickness strong enough to protect the liner.
    - (3) Grade the bottom to provide a sloping liner surface, from the outside edge of the filter toward the point of underdrain collection. Slopes must be equal to 8 inches fall overall or 1 inch of fall per 1 foot of run, whichever is the greater.
  - b. The sides of the pit must be smooth and free of possible puncture points from foreign objects.
  - c. Climatic conditions:
    - (1) Temperature. The desirable temperature range for membrane installation is 42° F to 78° F. Lower or higher temperatures may have an adverse effect on transportation, storage, field handling and placement, seaming and backfilling and attaching boots and patches may be difficult. Installing liners outside the desirable temperature range should be avoided at all times;

- (2) Wind. Wind may have an adverse effect on liner installation such as interfering with liner placement. Mechanical damage may result. Cleanliness of areas for boot connection and patching may not be possible. Alignment of seams and maintaining fabric cleanliness may not be possible. Installing the liner in high wind conditions should be avoided at all times;
  - (3) Precipitation. When field seaming is adversely affected by moisture, portable protective structures and/or other methods must be used to maintain a dry sealing surface. Proper surface preparation for bonding boots and patches may not be possible in wet conditions. Seaming, patching and attaching boots is recommended only during dry weather conditions.
- d. Boots: Any penetration through the PVC-lined wall shall be done with a PVC boot attachment glued to the liner with the vinyl sealer. The boot and exit pipe must be installed according to the following criteria:
- (1) The system designer must identify the use of a sand filter liner with underdrain and boot as a part of the application for on-site sewage system and provide specifications detailing design and installation requirements;
  - (2) The boot must be installed according to the manufacturer's requirements and watertight;
  - (3) The boot outlet must be bedded in sand;
  - (4) The boot must be sized to accommodate a 4" underdrain outlet pipe;
  - (5) The boot must be secured to the 4" underdrain outlet pipe with two (2) stainless steel bands and screws, and sealant strips as recommended by the manufacturer;
  - (6) The underdrain must be designed in accordance with Appendix C, Underdrains, and exit the side of the liner;
  - (7) An inspection port must be installed in a gravity sewer pipe from the sand filter to the drainfield;
  - (8) Gravity sewer pipe from the sand filter to the drainfield must be ASTM 3034 ring tight;
  - (9) When site conditions are such that the trench from the sand filter to drainfield may act as a conduit for groundwater movement towards the drainfield (for example on sites with shallow groundwater of poorly drained sites), the trench must be backfilled with a minimum 5 lineal feet clay mix (or bentonite mix) dam;

- (10) If the boot might be submerged in a seasonal high water table, performance testing of the sand filter/boot for leakage must be conducted in the following manner:
  - (a) Block outlet pipe;
  - (b) Fill underdrain gravel with water;
  - (c) Measure and record elevation of water through monitoring port;
  - (d) Let stand 24 hours minimum;
  - (e) Measure and record elevation of water through monitoring port;
  - (f) No allowable drop in the water level.
- e. Liner Placement:
  - (1) Size. The final cut size of the liner shall be carefully determined and ordered to generously fit the container geometry without field seaming or excess straining of the liner material;
  - (2) Transportation, handling and storage. Transportation, handling and storage procedures shall be planned to prevent material damage. Material shall be stored in a secured area and protected from adverse weather;
  - (3) Site inspection. A site inspection shall be carried out by the local health officer, other appropriate jurisdiction or by a designer or engineer appointed by the appropriate jurisdiction and the installer prior to liner installation to verify surface conditions, etc.;
  - (4) Deployment. Panels shall be positioned to minimize handling. Seaming should not be necessary. Bridging or stressed conditions shall be avoided with proper slack allowances for shrinkage. The liner shall be secured to prevent movement and promptly backfilled;
  - (5) Anchoring trenches. The liner edges should be secured frequently in a backfilled trench;
  - (6) Field seaming. Field seaming, if absolutely necessary, shall only be attempted when weather conditions are favorable. The contact surfaces of the materials should be clean of dirt, dust, moisture, or other foreign materials. The contact surfaces shall be aligned with sufficient overlap and bonded in accordance with the suppliers recommended procedures. Wrinkles shall be smoothed out and seams should be inspected by non-destructive testing techniques to verify their integrity. As seaming occurs

during installation, the field seams shall be inspected continuously and any faulty area repaired immediately;

- (7) Field repairs. It is important that traffic on the lined area be minimized. Any necessary repairs to the liner shall be patched using the same lining material and following the recommended procedure of the supplier;
- (8) Final inspection and acceptance. Completed liner installations shall be visually checked for punctures, rips, tears, and seam gaps before placement of any backfill. At this time the installer shall also manually check all factory and field seams with an appropriate tool. In lieu of, or in addition to manual checking of seams by the installer, either of the following tests may be performed;
  - (a) Wet Test: The lined basin shall be flooded to the one (1) foot level with water after inlets and outlets have been plugged. There shall not be any loss of water in a 24-hour test period;
  - (b) Air Lance Test: Check all bonded seams using a minimum 50 PSI (gauge) air supply directed through a 3/16 inch (typical) nozzle held not more than 2 inches from the seam edge and directed at the seam edge. Riffles indicate unbonded areas within the seam, or other undesirable seam construction.

### C. Lined Framework

1. A perimeter support frame to hold the liner in place during construction must be used. The supporting framework may be constructed of wood or cast-in-place concrete. Framework shall be straight, free from warps or bends. Framework shall be of sufficient rigidity so that springing will not occur under the weight of the media and/or backfill placement. Framework shall be sufficiently supported to prevent excessive deflection of the framework.

*When plywood is used, a 2x4 framing support (on 2' centers minimum) is a suggested construction method. Treated wood should be used to prevent deterioration of the wood by termites, decomposition, etc.*

### D. Filter media and liner placement

1. It is important that, simultaneous with the placement of the filter media, sand is placed between the wooden framework and excavated soil. This keeps the framework and liner vertical during the course of construction and results in a sand cushion around the outside perimeter of the lined framework. All nails or staples used must have their sharp ends pointed away from the liner. The PVC liner is unfolded from the center of the excavation and draped over the top edges of the perimeter support

frame. Care should be taken to prevent contact between the liner and the sharp edges of the top of the perimeter support frame.

*A garden hose, which has been cut longitudinally and placed on the top edge of the support frame, would be a suggested method to prevent contact.*

2. Care must be taken to ensure that the liner is in full contact with the bottom and sides and that no bridging occurs.

*Pleats or wrinkles in the liner should be minimized. Pleats and wrinkles in the liner may allow for a tunneling effect of effluent through the pleat or wrinkle.*

#### **E. Backfill around framework**

1. If site conditions are such that a partially elevated filter is desired or necessary, backfill around the sides of the filter shall be non-clay material containing no pieces larger than 3 inches across, any frozen lumps, and any wood or other foreign material. The backfill material around the sides of the filter shall be placed in loose layers no more than 2 feet thick, with each layer tamped and graded so that final settling will provide for side slopes on the sides of the filter backfill to be approximately 3:1 from the top of the filter, to the original ground.

## **II. Concrete Containment Vessels**

- A. Concrete containment vessels must be reviewed and approved by the department as a concrete cast-in-place tank according the sewage tank requirements in WAC 246-272C.

## Appendix C – Underdrains

For Synthetic Membrane-Lined Pits or concrete cast-in-place containment vessels: Sand filter filtrate is collected in an underdrain underlying the filter media. Either a gravity discharge underdrain or pump discharge underdrain may be used.

Underdrains must be designed with sufficient void storage volume to provide for a single drainfield dose with reserve capacity to maintain unsaturated filter media above the underdrain system. The collection pipe must be of sufficient size, with adequate perforations, or slots so that filtrate can flow from the void storage space into the collection pipe rapidly enough to maintain unsaturated filter media above the underdrain system. However, the minimum size of the collection pipe shall be 4” diameter.

Underdrains may be designed in a variety of ways. One possible way is:

Place a 3-inch layer of pea gravel over at least a 6-inch layer of 3/4 to 2-1/2 inch gravel containing the underdrain collection pipe. The purpose of the pea gravel is to restrict the migration of sand into the gravel and pipe in the underdrain. The gravel surrounding the slotted or perforated pipe should be sized larger than the slots or perforations to prevent migration of gravel into the pipe. This is commonly accomplished by using 4” slotted pipe with slots 0.25 in. wide, 4 inches on center, and cut halfway through the pipe. The slots are placed at the “12 o’clock position” so they are not blocked by settlement into the liner. See figure 7 below.

**Figure 7 - Typical Cross-section of a Gravity Discharge Underdrain**

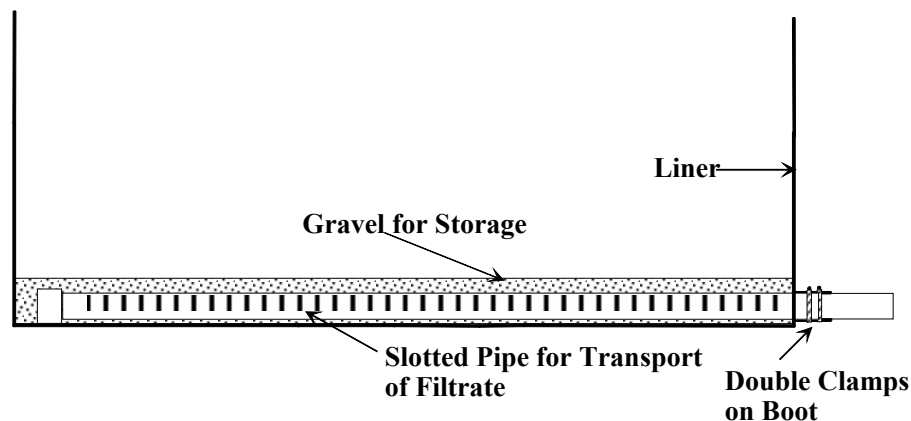

### I. Internal Pump Basin Assemblies

When a pump discharge underdrain is used, filtrate is collected in the underdrain system underlying the filter media and is discharged directly into the pumpwell located within the sand filter. The pumpwell is installed in an excavation depression located in the center of the filter. The size and shape of the excavation must be adequate for the pump, pump controls, and other necessary equipment.

The pump basin may be designed a variety of ways, but they are typically constructed of large-diameter PVC ribbed pipe (see Figure 8). A sufficient number and size of holes must exist in the pump basin, at the level of the underdrain system, so that filtrate can flow into the pump basin, from the underdrain void space, as rapidly as the filtrate is pumped out of the pump basin. The pump basin must be adequately supported on both sides of the synthetic membrane. The underdrain pipes should penetrate the pumpwell 1 to 2 inches.

**Figure 8 - Typical Cross-section of an Pump Discharge Underdrain**

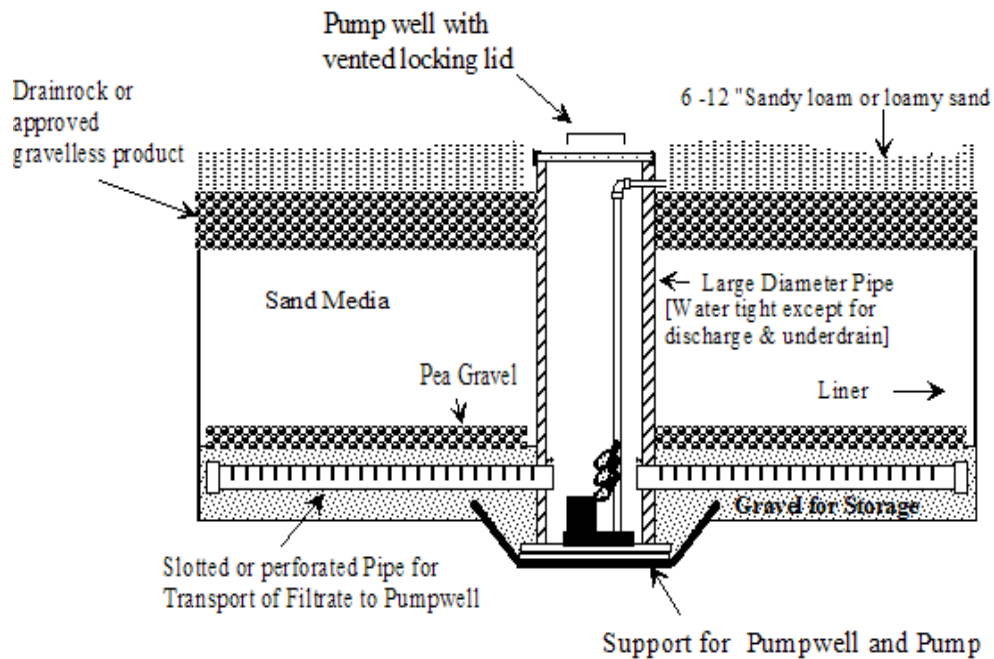



### Appendix D - Monitoring Ports

Note: ports should only be perforated or slotted at the bottom

Figure 9 - Typical Monitoring Ports

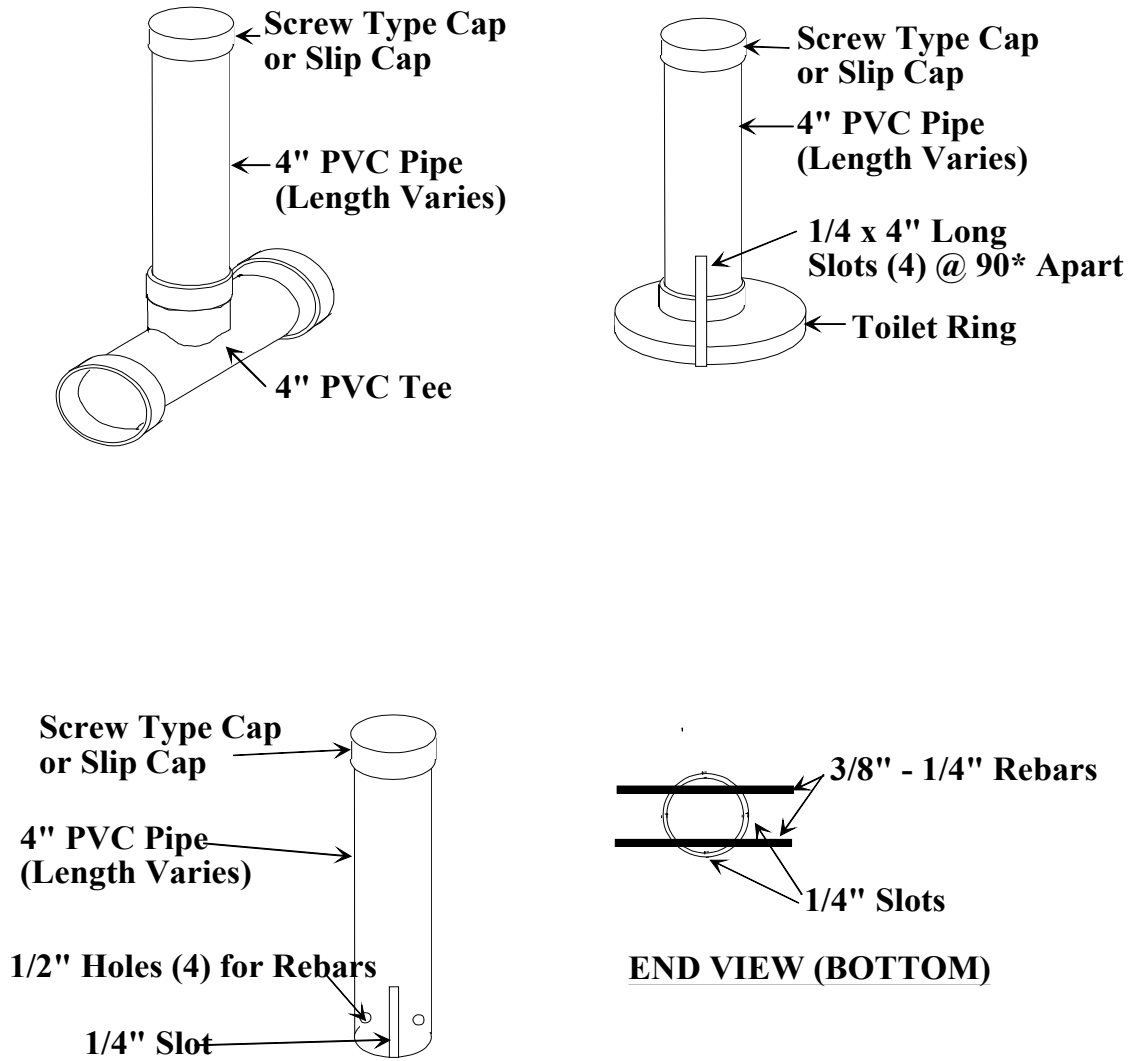

## Appendix E - Disposal of Contaminated Filter Media

Whenever filter media is removed from a used filter, removing and disposing of contaminated filter media must be done in a manner approved by the local health officer. Handle this material carefully by using adequate protective sanitation measures. Thoroughly wash hands and any other exposed skin with hot water and soap, following contact with contaminated sand filter media.

The contaminated filter media can be buried with at least 6 inches of cover on a site approved by the local health officer. If the material must be placed at grade, it must be covered with at least a 6-inch soil cap. Sloping sites should be avoided.

For either of these methods, the drainfield setbacks and vertical separations requirements in WAC 246-272A must be met and the material must not be used in agronomic applications for 12 months.

If the material must be disposed of at the local sanitary landfill, contact them for their requirements.

The material may be used for agricultural production, in accordance with the following guidance, when approved by the local health officer.

APPLICATION	RESTRICTIONS/TIMETABLE
1. Root crops, low-growing vegetables, fruits, berries used for human consumption.	Contaminated material must be stabilized and applied 12 months prior to planting.
2. Forage and pasture crops for consumption by dairy cattle.	Forage and pasture crops not available until one month following application of stabilized material.
3. Forage and pasture crops for consumption by non-dairy livestock.	Forage and pasture crops not available until two weeks following application of stabilized material.
4. Orchards or other agricultural area where the material will not directly contact food products, or where stabilized material has undergone further treatment, such as pathogen reduction or sterilization.	Less severe restrictions may be applicable.

*Stabilization may be accomplished by increasing the pH to 12 with the addition of a supplement such as lime.*

## **Appendix F - Bibliography**

Boyle, W.C. and Richard J. Otis, "On-Site Treatment", EPA Training Manual, Prepared for Environmental Research Information Center, ORD, USEPA, July 1979.

Converse, Matthew M., A Field Evaluation of Single Pass Sand Filters in a Northern Climate, Masters Degree Thesis, Master of Science, University of Wisconsin-Madison, 1999.

Design Manual: On-site Wastewater Treatment and Disposal Systems. U.S. EPA, EPA-625/1-80-012 October 1980

Final Report, Oregon On-site Experimental Systems Program, December 1982; Oregon Department of Environmental Quality

Glossary of Water and Wastewater Control Engineering; Joint Editorial Board of the AWWA, WPCF, ASCE, APHA, Copyright 1969

Gross, Mark A., Optimum Depth of Sand for Filtering Septic Tank Effluent; Masters Degree Thesis, Master of Science, University Of Arkansas, 1981.

Gross, Mark, Dee T. Mitchell, Biological Virus Removal from Household Septic Tank Effluent; Proceedings of the Fourth National Symposium on Individual and Small Community Sewage Systems, ASAE, December 1984, New Orleans, Louisiana.

Gross, Mark, Ph.D., P.E., Dee Mitchell, Household Wastewater Virus Removal by Sand Filtration; 1988 Revision.

Hathaway, Randy J., Dee T. Mitchell, Sand Filtration of Septic Tank Effluent For All Seasons Disposal By Irrigation, Proceedings of the Fourth National Symposium on Individual and Small Community Sewage Systems, December 1984, New Orleans, Louisiana

Hines, Michael and R.E. Favreau, Recirculating Sand Filter: An Alternative to Traditional Sewage Absorption Systems, Proceedings of National Home Sewage Disposal Symposium, December 1974.

Koerner, Robert M., Ph.D., P.E., Designing with Geosynthetics, Prentice-Hall

Loudon, T.L., G.L. Birnie, Jr., Performance of Trenches Receiving Sand Filter Effluent in Slowly Permeable Soils, Proceedings of the 6th National Symposium on Individual and Small Community Sewage Systems, ASAE, December, 1991, Chicago, IL.

Management of Small Waste Flows, Final Report of the Small Scale Management Project, University of Wisconsin, EPA 600/2-78-173.

Mitchell, Dee, Sand Filtration of Septic Tank Effluent, Proceedings of the 5th Northwest On-site Wastewater Treatment Short Course, University of Washington, September 1985

Mitchell, Mike D. P.E., Writings, Northwest Septic, Inc., Mt. Vernon, Washington.

On the Performance of Experimental Sand Filters in the State of Oregon, Oregon Department of Environmental Quality.

Otis, Richard, P.E., Soil Clogging: Mechanisms and Control, Proceedings of the 4th National Symposium on Individual and Small Community Sewage Systems, ASAE, December 1984, New Orleans, LA.

Otis, Richard J., P.E., On-site Wastewater Treatment Intermittent Sand Filters, Rural Systems Engineering, Madison, Wisconsin.

Sauer, D.K., W.C. Boyle, and Richard J. Otis. "Intermittent Sand Filtration." ASCE/EE, August 1976

Scherer, Billy P., Dee T. Mitchell, Individual Household Surface Disposal of Treated Wastewater without Chlorination; Proceedings of the Third National Symposium on Individual and Small Community Sewage Treatment, December 1981, Chicago, Illinois.

Siegrist, Robert L., Hydraulic Loading Rates for Soil Absorption Systems Based on Wastewater Quality, Proceedings of the 5th National Symposium on Individual and Small Community Sewage Systems, ASAE, December 1987, Chicago, IL

Technology Assessment of Intermittent Sand Filters. U.S. EPA, Office of Municipal Pollution Control, Project Officer: James F. Kreissl. Authors: Damann L. Anderson, Robert L. Seigrist, Richard J. Otis.

Tyler, E. Jerry, James C. Converse, Soil Acceptance of Onsite Wastewater as Affected by Soil Morphology and Wastewater Quality, Proceedings of the 7th International Symposium on Individual and Small Community Sewage Systems, ASAE, December 1994, Atlanta, GA.